



# TO-220-3L Plastic-Encapsulate Voltage Regulators

## CJ7806 Three-terminal positive voltage regulator

### FEATURES

- Maximum Output current  $I_{OM}$ : 1.5 A
- Output voltage  $V_o$ : 6 V
- Continuous total dissipation
  - $P_D$ : 1.5 W ( $T_a=25^\circ\text{C}$ )
  - 15 W ( $T_c=25^\circ\text{C}$ )

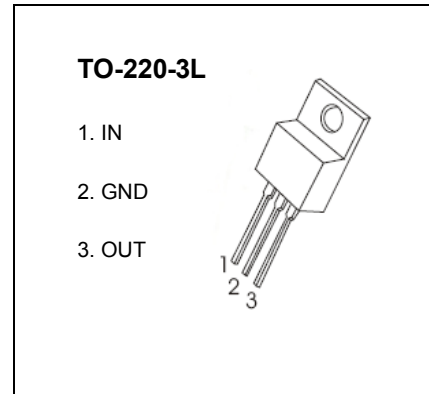

### ABSOLUTE MAXIMUM RATINGS (operating temperature range applies unless otherwise specified)

Parameter	Symbol	Value	Unit
Input Voltage	$V_i$	35	V
Thermal Resistance from Junction to Ambient	$R_{\theta JA}$	83.3	$^\circ\text{C/W}$
Thermal Resistance from Junction to Case	$R_{\theta JC}$	8.3	$^\circ\text{C/W}$
Operating Junction Temperature Range	$T_{OPR}$	0~+150	$^\circ\text{C}$
Storage Temperature Range	$T_{STG}$	-55~+150	$^\circ\text{C}$

### ELECTRICAL CHARACTERISTICS AT SPECIFIED VIRTUAL JUNCTION TEMPERATURE ( $V_i=11\text{V}, I_o=500\text{mA}, C_i=0.33\mu\text{F}, C_o=0.1\mu\text{F}$ , unless otherwise specified)

Parameter	Symbol	Test conditions	MIN	TYP	MAX	UNIT
Output voltage	$V_o$	$25^\circ\text{C}$	5.75	6	6.25	V
		$8\text{V} \leq V_i \leq 21\text{V}, I_o=5\text{mA}-1\text{A}, P \leq 15\text{W}$ $0-125^\circ\text{C}$	5.7	6	6.3	V
Load Regulation	$\Delta V_o$	$I_o=5\text{mA}-1.5\text{A}$ $25^\circ\text{C}$		14	120	mV
		$I_o=250\text{mA}-750\text{mA}$ $25^\circ\text{C}$		4	60	mV
Line regulation	$\Delta V_o$	$8\text{V} \leq V_i \leq 25\text{V}$ $25^\circ\text{C}$		5	120	mV
		$9\text{V} \leq V_i \leq 13\text{V}$ $25^\circ\text{C}$		1.5	60	mV
Quiescent Current	$I_q$	$25^\circ\text{C}$		4.3	8	mA
Quiescent Current Change	$\Delta I_q$	$8\text{V} \leq V_i \leq 25\text{V}$ $0-125^\circ\text{C}$			1.3	mA
		$5\text{mA} \leq I_o \leq 1\text{A}$ $0-125^\circ\text{C}$			0.5	mA
Output voltage drift	$\Delta V_o/\Delta T$	$I_o=5\text{mA}$ $0-125^\circ\text{C}$		-0.8		mV/ $^\circ\text{C}$
Output Noise Voltage	$V_N$	$10\text{Hz} \leq f \leq 100\text{KHz}$ $25^\circ\text{C}$		45		$\mu\text{V}$
Ripple Rejection	RR	$9\text{V} \leq V_i \leq 19\text{V}, f=120\text{Hz}$ $0-125^\circ\text{C}$	59	75		dB
Dropout Voltage	$V_d$	$I_o=1\text{A}$ $25^\circ\text{C}$		2		V
Output resistance	$R_o$	$f=1\text{KHz}$ $25^\circ\text{C}$		10		m $\Omega$
Short Circuit Current	$I_{sc}$	$25^\circ\text{C}$		550		mA
Peak Current	$I_{pk}$	$25^\circ\text{C}$		2.2		A

### TYPICAL APPLICATION

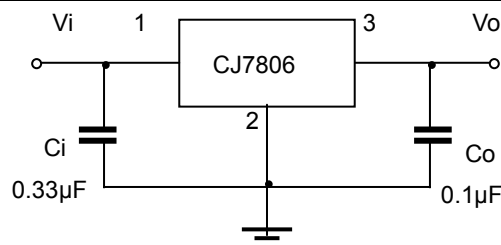

# Typical Characteristics

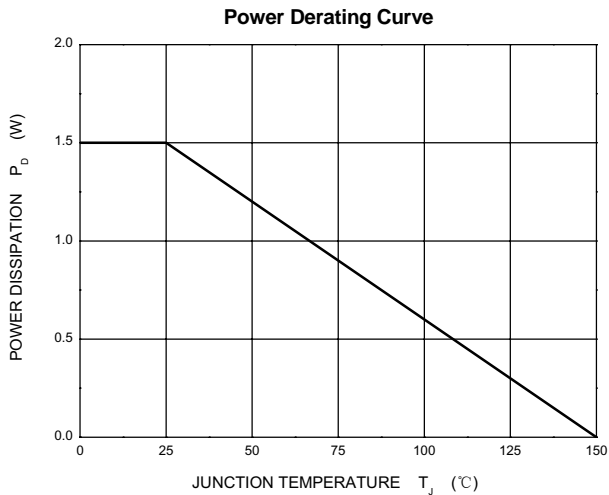
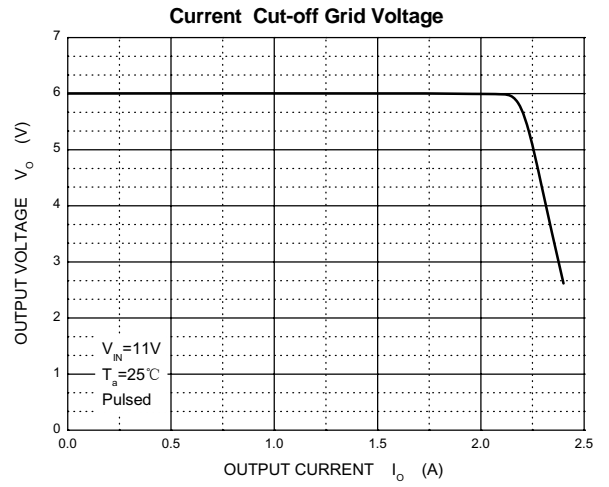
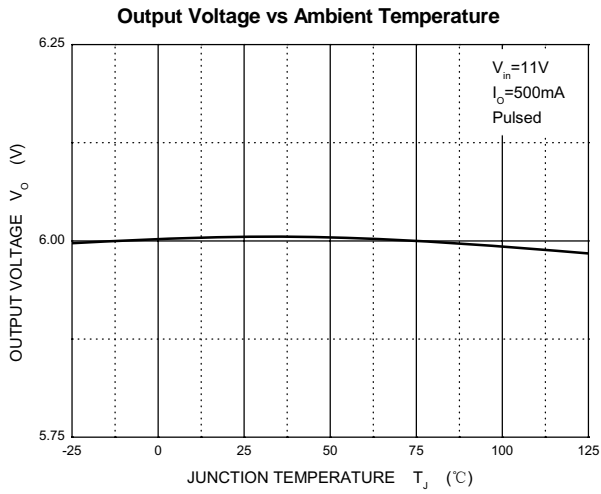
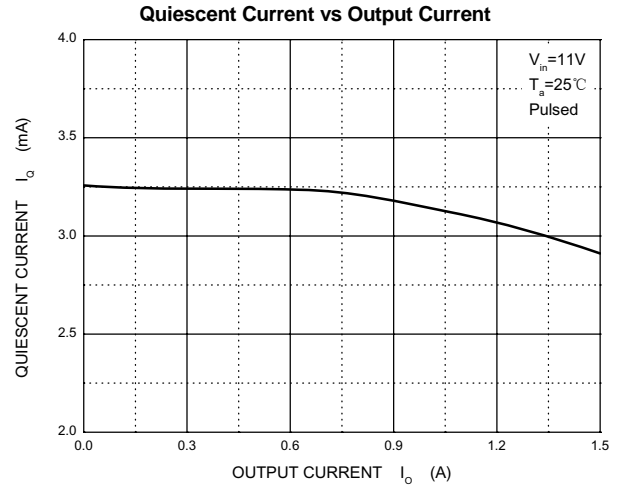
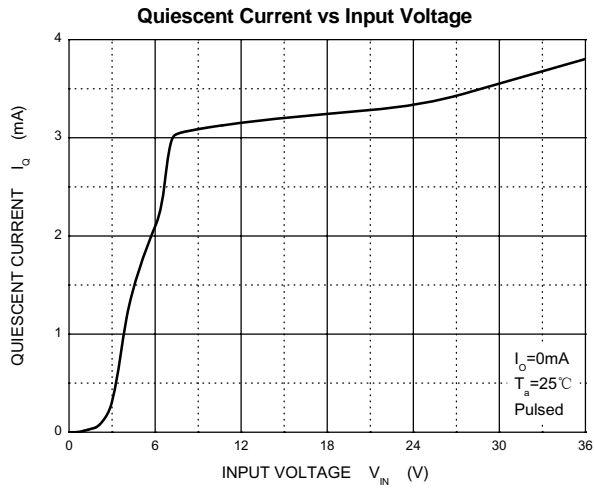
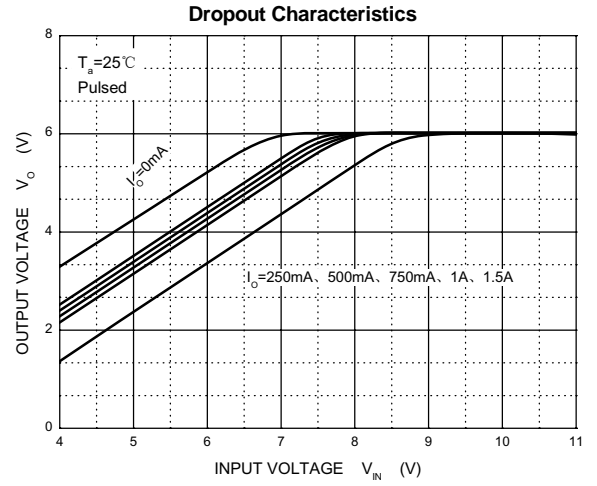
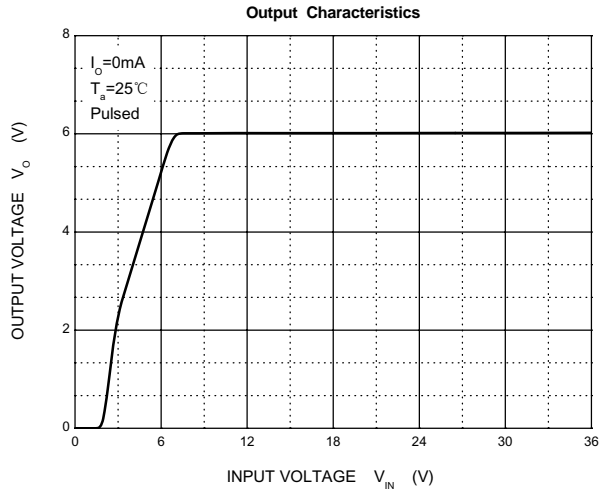

# TO-220-3L Package Outline Dimensions

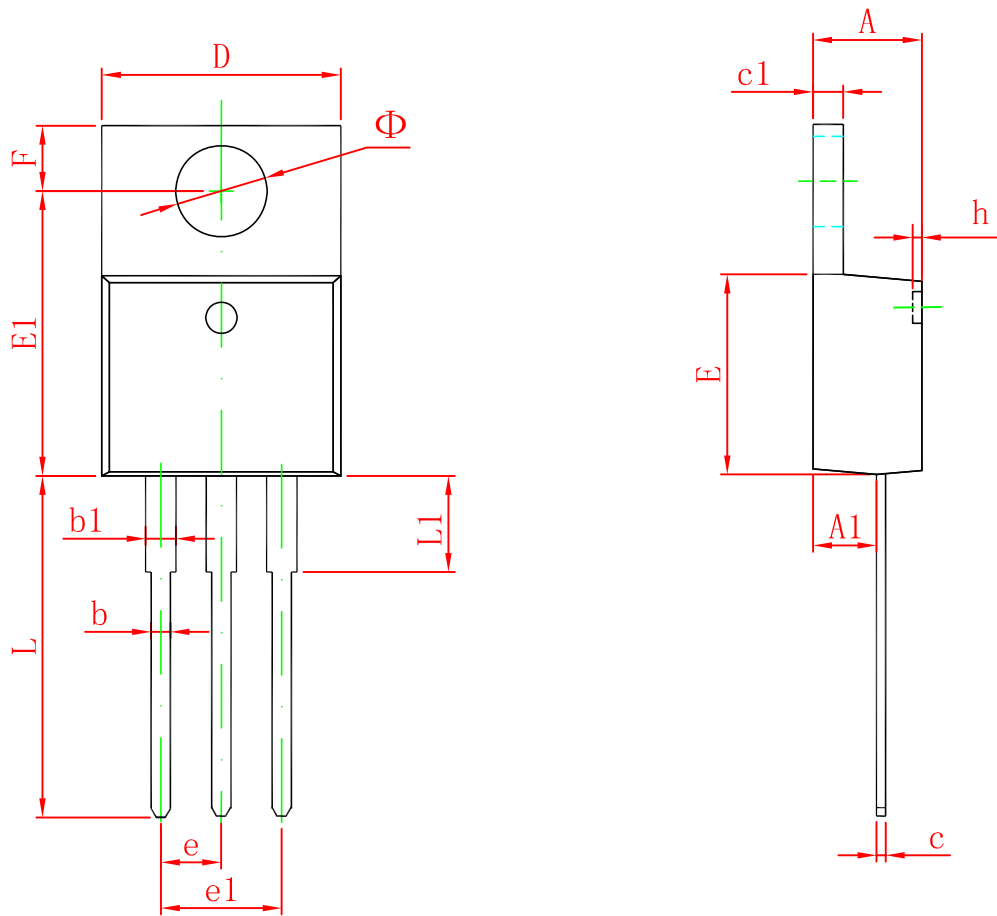

Symbol	Dimensions In Millimeters		Dimensions In Inches	
	Min	Max	Min	Max
A	4.470	4.670	0.176	0.184
A1	2.520	2.820	0.099	0.111
b	0.710	0.910	0.028	0.036
b1	1.170	1.370	0.046	0.054
c	0.310	0.530	0.012	0.021
c1	1.170	1.370	0.046	0.054
D	10.010	10.310	0.394	0.406
E	8.500	8.900	0.335	0.350
E1	12.060	12.460	0.475	0.491
e	2.540 TYP		0.100 TYP	
e1	4.980	5.180	0.196	0.204
F	2.590	2.890	0.102	0.114
h	0.000	0.300	0.000	0.012
L	13.400	13.800	0.528	0.543
L1	3.560	3.960	0.140	0.156
$\Phi$	3.735	3.935	0.147	0.155