

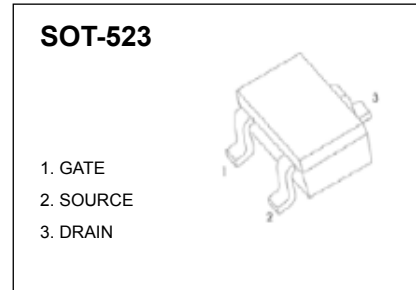

SOT-523 Plastic-Encapsulate MOSFETS

2N7002T MOSFET (N-Channel)

| $V_{(BR)DSS}$ | $R_{DS(on)MAX}$ | I_D |
|---------------|-----------------|-------|
| 60V | 5Ω@10V | 115mA |
| | 7Ω@5V | |



FEATURE

- High density cell design for low $R_{DS(ON)}$
- Voltage controlled small signal switch
- Rugged and reliable
- High saturation current capability

APPLICATION

- Load Switch for Portable Devices
- DC/DC Converter

MARKING

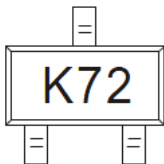

Equivalent Circuit

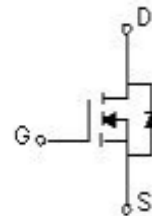

MAXIMUM RATINGS ($T_a=25^\circ\text{C}$ unless otherwise noted)

| Symbol | Parameter | Value | Unit |
|-----------------|---|----------|--------------------|
| V_{DS} | Drain-Source voltage | 60 | V |
| V_{GS} | Gate-Source voltage | 20 | V |
| I_D | Drain Current | 115 | mA |
| P_D | Power Dissipation | 150 | mW |
| $R_{\theta JA}$ | Thermal Resistance from Junction to Ambient | 833 | $^\circ\text{C/W}$ |
| T_J | Junction Temperature | 150 | $^\circ\text{C}$ |
| T_{stg} | Storage Temperature | -55~+150 | $^\circ\text{C}$ |

MOSFET ELECTRICAL CHARACTERISTICS

$T_a=25\text{ }^\circ\text{C}$ unless otherwise specified

| Parameter | Symbol | Test conditions | Min | Typ | Max | Unit |
|---------------------------------|---------------|---|------|-----|----------|----------|
| Drain-Source Breakdown Voltage | $V_{(BR)DSS}$ | $V_{GS}=0\text{ V}, I_D=250\text{ }\mu\text{A}$ | 60 | | | V |
| Gate-Threshold Voltage | $V_{th(GS)}$ | $V_{DS}=V_{GS}, I_D=250\text{ }\mu\text{A}$ | 1 | | 2.5 | |
| Gate-body Leakage | I_{GSS} | $V_{DS}=0\text{ V}, V_{GS}=\pm 20\text{ V}$ | | | ± 80 | nA |
| Zero Gate Voltage Drain Current | I_{DSS} | $V_{DS}=60\text{ V}, V_{GS}=0\text{ V}$ | | | 80 | nA |
| On-state Drain Current | $I_{D(ON)}$ | $V_{GS}=10\text{ V}, V_{DS}=7\text{ V}$ | 500 | | | mA |
| Drain-Source On-Resistance | $R_{DS(on)}$ | $V_{GS}=10\text{ V}, I_D=500\text{ mA}$ | | | 5 | Ω |
| | | $V_{GS}=5\text{ V}, I_D=50\text{ mA}$ | | | 7 | |
| Forward Trans conductance | g_{fs} | $V_{DS}=10\text{ V}, I_D=200\text{ mA}$ | 80 | | | ms |
| Drain-source on-voltage | $V_{DS(on)}$ | $V_{GS}=10\text{ V}, I_D=500\text{ mA}$ | | | 3.75 | V |
| | | $V_{GS}=5\text{ V}, I_D=50\text{ mA}$ | | | 0.375 | V |
| Diode Forward Voltage | V_{SD} | $I_S=115\text{ mA}, V_{GS}=0\text{ V}$ | 0.55 | | 1.2 | V |
| Input Capacitance | C_{iss} | $V_{DS}=25\text{ V}, V_{GS}=0\text{ V}, f=1\text{ MHz}$ | | | 50 | pF |
| Output Capacitance | C_{oss} | | | | 25 | |
| Reverse Transfer Capacitance | C_{rss} | | | | 5 | |

SWITCHING TIME

| | | | | | | |
|---------------|--------------|--|--|--|----|----|
| Turn-on Time | $t_{d(on)}$ | $V_{DD}=25\text{ V}, R_L=50\Omega$ | | | 20 | ns |
| Turn-off Time | $t_{d(off)}$ | $I_D=500\text{ mA}, V_{GEN}=10\text{ V}$ $R_G=25\text{ }\Omega$ | | | 40 | |

Typical Characteristics

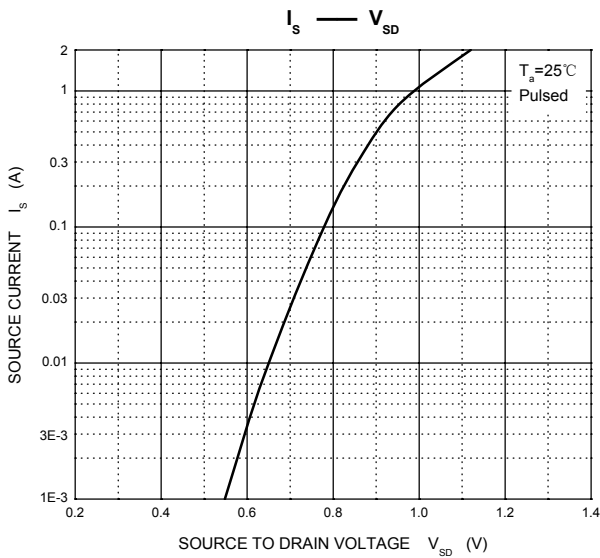
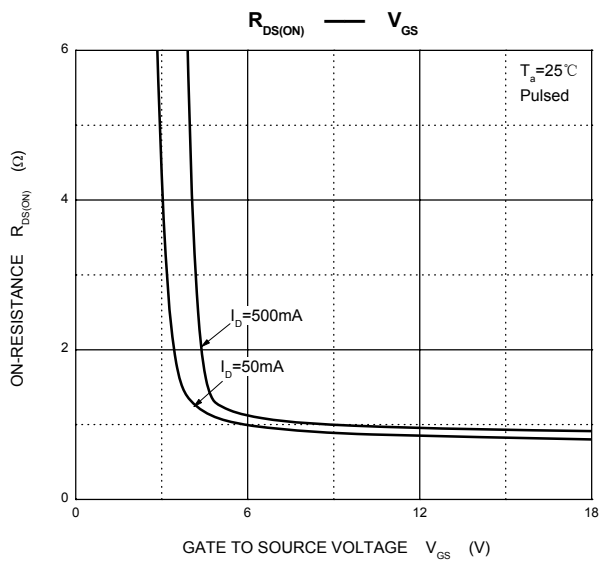
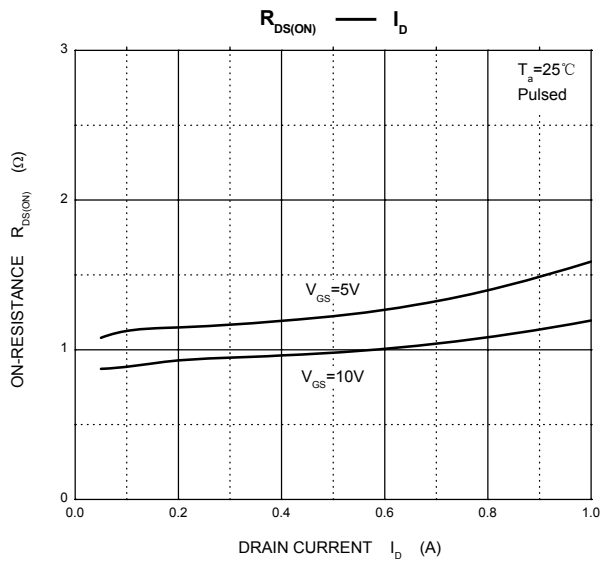
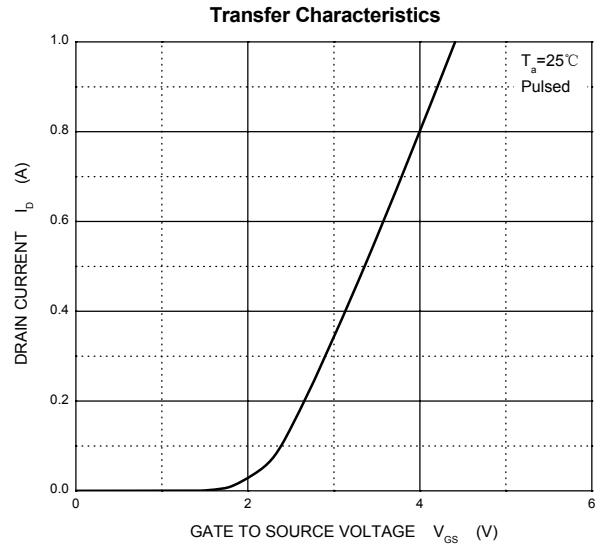
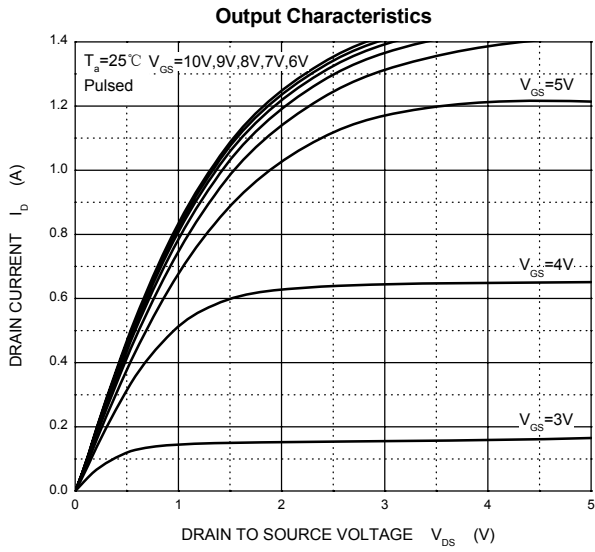

SOT-523 Package Outline Dimensions

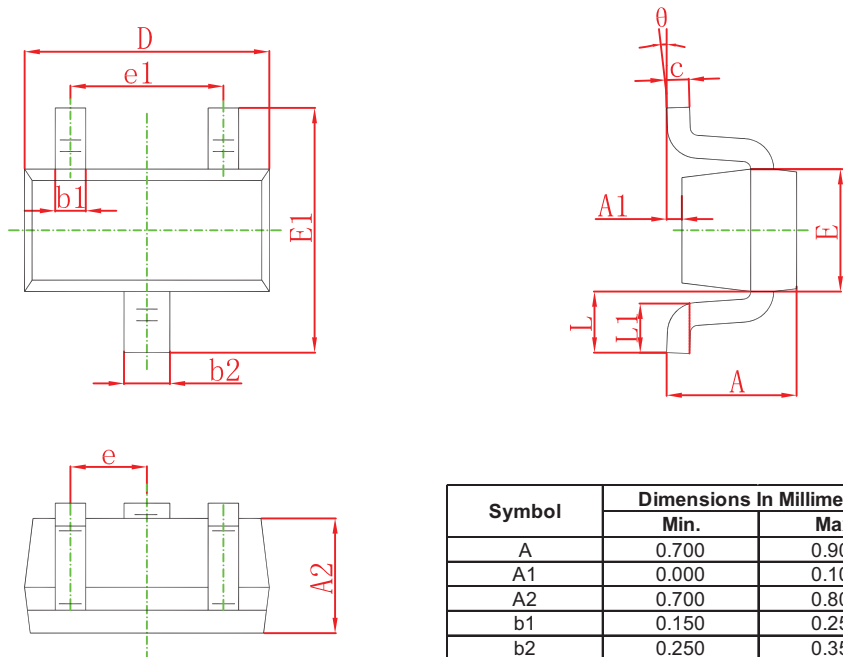

| Symbol | Dimensions In Millimeters | | Dimensions In Inches | |
|--------|---------------------------|-------|----------------------|-------|
| | Min. | Max. | Min. | Max. |
| A | 0.700 | 0.900 | 0.028 | 0.035 |
| A1 | 0.000 | 0.100 | 0.000 | 0.004 |
| A2 | 0.700 | 0.800 | 0.028 | 0.031 |
| b1 | 0.150 | 0.250 | 0.006 | 0.010 |
| b2 | 0.250 | 0.350 | 0.010 | 0.014 |
| c | 0.100 | 0.200 | 0.004 | 0.008 |
| D | 1.500 | 1.700 | 0.059 | 0.067 |
| E | 0.700 | 0.900 | 0.028 | 0.035 |
| E1 | 1.450 | 1.750 | 0.057 | 0.069 |
| e | 0.500 TYP. | | 0.020 TYP. | |
| e1 | 0.900 | 1.100 | 0.035 | 0.043 |
| L | 0.400 REF. | | 0.016 REF. | |
| L1 | 0.260 | 0.460 | 0.010 | 0.018 |
| θ | 0° | 8° | 0° | 8° |

SOT-523 Suggested Pad Layout

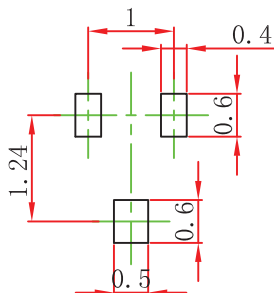

- Note:
1. Controlling dimension: in millimeters.
 2. General tolerance: $\pm 0.05\text{mm}$.
 3. The pad layout is for reference purposes only.

NOTICE

JCET reserve the right to make modifications, enhancements, improvements, corrections or other changes without further notice to any product herein. JCET does not assume any liability arising out of the application or use of any product described herein.

SOT-523 Tape and Reel

SOT-523 Embossed Carrier Tape

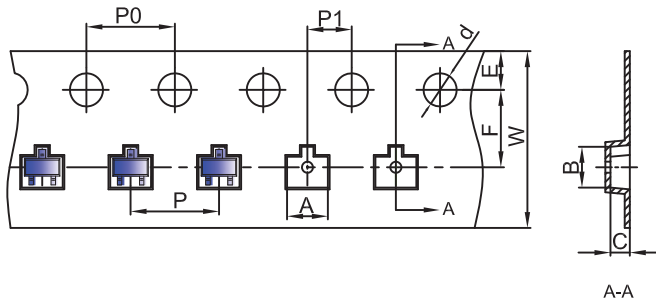

Packaging Description:

SOT-523 parts are shipped in tape. The carrier tape is made from a dissipative (carbon filled) polycarbonate resin. The cover tape is a multilayer film (Heat Activated Adhesive in nature) primarily composed of polyester film, adhesive layer, sealant, and anti-static sprayed agent. These reeled parts in standard option are shipped with 3,000 units per 7" or 17.8cm diameter reel. The reels are clear in color and is made of polystyrene plastic (anti-static coated).

Dimensions are in millimeter

| Pkg type | A | B | C | d | E | F | P0 | P | P1 | W |
|----------|------|------|-------|-------|------|------|------|------|------|------|
| SOT-523 | 1.85 | 1.85 | 0.875 | Ø1.50 | 1.75 | 3.50 | 4.00 | 4.00 | 2.00 | 8.00 |

SOT-523 Tape Leader and Trailer

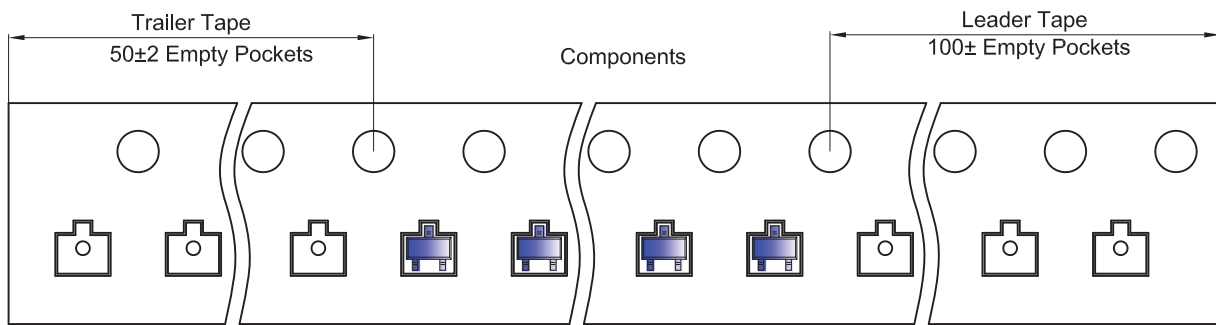

SOT-523 Reel

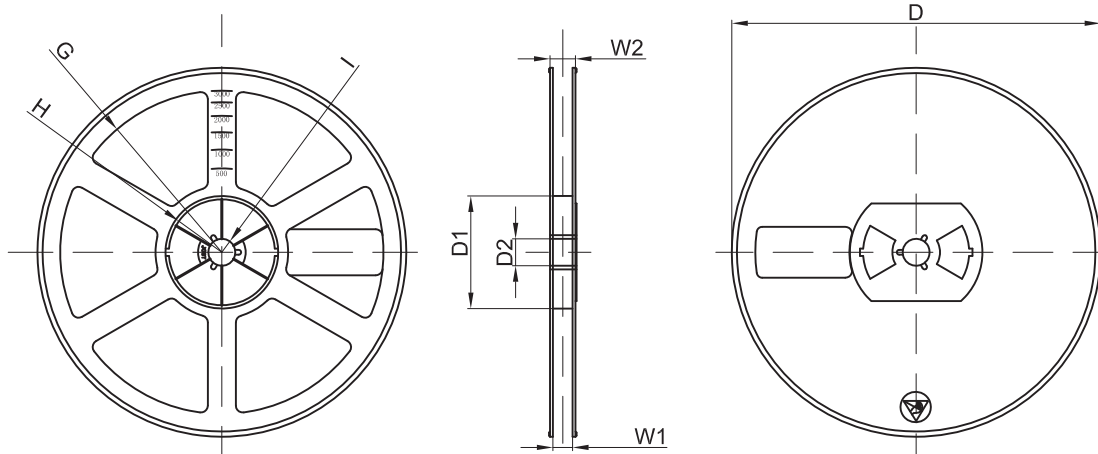

Dimensions are in millimeter

| Reel Option | D | D1 | D2 | G | H | I | W1 | W2 |
|-------------|---------|-------|-------|--------|--------|-------|------|-------|
| 7" Dia | Ø178.00 | 54.40 | 13.00 | R78.00 | R25.60 | R6.50 | 9.50 | 12.30 |

| REEL | Reel Size | Box | Box Size(mm) | Carton | Carton Size(mm) | G.W.(kg) |
|----------|-----------|------------|--------------|-------------|-----------------|----------|
| 3000 pcs | 7 inch | 45,000 pcs | 203×203×195 | 180,000 pcs | 438×438×220 | |