

## SOT-23-6L Plastic-Encapsulate Transistors

### CJ2045 Dual 40V complementary transistors

#### FEATURES

- 40V complementary device
- High  $h_{FE}$
- Mounting cost and area can be cut in half

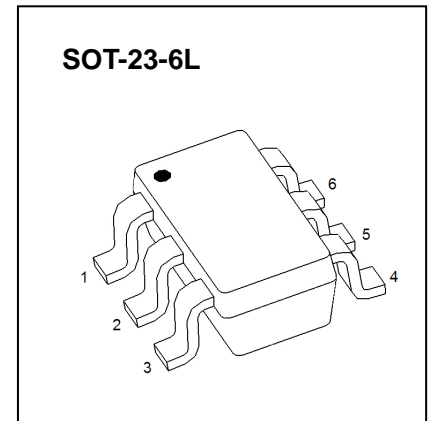

#### MARKING



PIN1

#### EQUIVALENT CIRCUIT

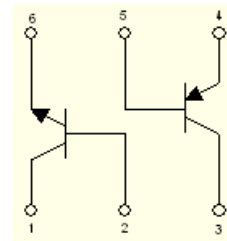

#### Tr1 NPN and Tr2 PNP Absolute Maximum Ratings ( $T_a=25^\circ\text{C}$ )

Symbol	Parameter	Value		Unit
		NPN	PNP	
$V_{CBO}$	Collector-Base Voltage	40	-40	V
$V_{CEX}$	Collector-Emitter Voltage	40	-40	V
$V_{CEO}$	Collector-Emitter Voltage	30	-30	V
$V_{EBO}$	Emitter-Base Voltage	7	-7	V
$I_C$	Collector Current- Continuous	1.5	-1.5	A
$I_{CM}$	Collector Current- Peak	5	-5	A
$P_C$	Collector Power Dissipation	350	350	mW
$R_{\theta JA}$	Thermal Resistance from Junction to Ambient	357	357	$^\circ\text{C}/\text{W}$
$T_J$	Junction Temperature	150		$^\circ\text{C}$
$T_{stg}$	Storage Temperature	-55~+150		$^\circ\text{C}$

## ELECTRICAL CHARACTERISTICS

### Tr1 NPN ( $T_a=25^\circ\text{C}$ unless otherwise specified)

Parameter	Symbol	Test conditions	Min	Typ	Max	Unit
Collector-base breakdown voltage	$V_{(BR)CBO}$	$I_C=100\mu\text{A}$ , $I_E=0$	40			V
Collector-emitter breakdown voltage	$V_{(BR)CEO}^*$	$I_C=10\text{mA}$ , $I_B=0$	30			V
Collector-emitter breakdown voltage	$V_{(BR)CEX}$	$I_C=1\mu\text{A}$ , $V_{BE(off)}=-0.5\text{V}$	40			V
Emitter-base breakdown voltage	$V_{(BR)EBO}$	$I_E=100\mu\text{A}$ , $I_C=0$	7			V
Collector cut-off current	$I_{CBO}$	$V_{CB}=32\text{V}$ , $I_E=0$			20	nA
Collector cut-off current	$I_{CER}$	$V_{CE}=16\text{V}$ , $R\leq 1\text{k}\Omega$			20	nA
Emitter cut-off current	$I_{EBO}$	$V_{EB}=6\text{V}$ , $I_C=0$			20	nA
DC current gain	$h_{FE}^*$	$V_{CE}=2\text{V}$ , $I_C=100\text{mA}$	180		500	
Collector-emitter saturation voltage	$V_{CE(sat)}^*$	$I_C=750\text{mA}$ , $I_B=15\text{mA}$			0.375	V
Base-emitter saturation voltage	$V_{BE(sat)}^*$				1.2	V

### Tr2 PNP ( $T_a=25^\circ\text{C}$ unless otherwise specified)

Parameter	Symbol	Test conditions	Min	Typ	Max	Unit
Collector-base breakdown voltage	$V_{(BR)CBO}$	$I_C=-100\mu\text{A}$ , $I_E=0$	-40			V
Collector-emitter breakdown voltage	$V_{(BR)CEO}^*$	$I_C=-10\text{mA}$ , $I_B=0$	-30			V
Collector-emitter breakdown voltage	$V_{(BR)CEX}$	$I_C=-1\mu\text{A}$ , $V_{BE(off)}=0.5\text{V}$	-40			V
Emitter-base breakdown voltage	$V_{(BR)EBO}$	$I_E=-100\mu\text{A}$ , $I_C=0$	-7			V
Collector cut-off current	$I_{CBO}$	$V_{CB}=-32\text{V}$ , $I_E=0$			-20	nA
Collector cut-off current	$I_{CER}$	$V_{CE}=-16\text{V}$ , $R\leq 1\text{k}\Omega$			-20	nA
Emitter cut-off current	$I_{EBO}$	$V_{EB}=-6\text{V}$ , $I_C=0$			-20	nA
DC current gain	$h_{FE}^*$	$V_{CE}=-2\text{V}$ , $I_C=-100\text{mA}$	180		500	
Collector-emitter saturation voltage	$V_{CE(sat)}^*$	$I_C=-750\text{mA}$ , $I_B=-15\text{mA}$			-0.375	V
Base-emitter saturation voltage	$V_{BE(sat)}^*$				-1.2	V

\*Pulse Test : Pulse Width $\leq 300\mu\text{s}$ , Duty Cycle $\leq 2\%$ .

# Typical Characteristics

## NPN Transistor

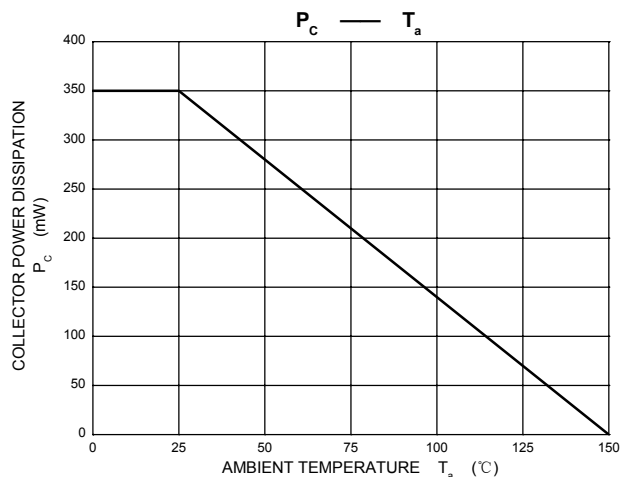
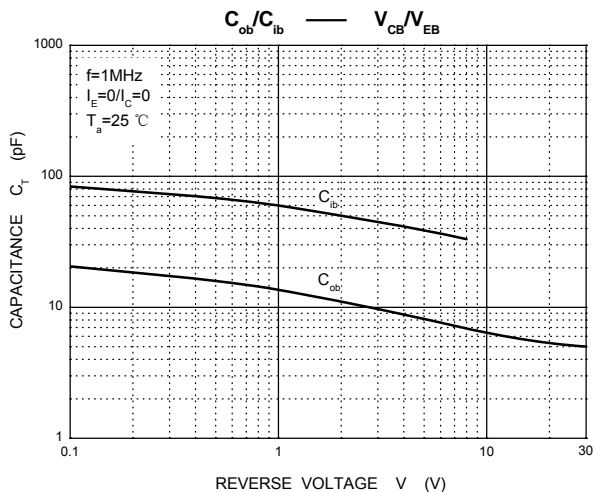
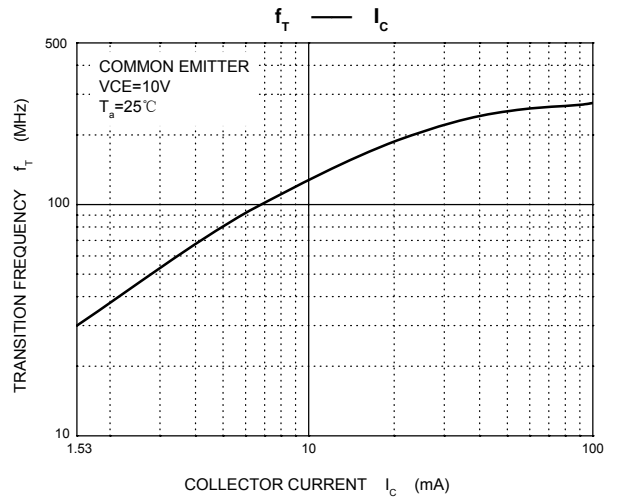
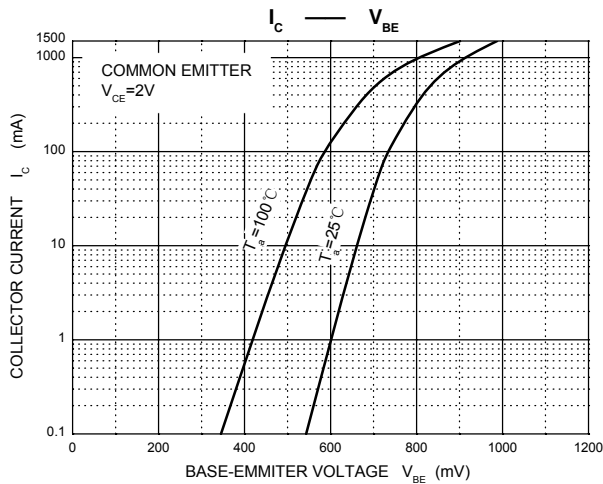
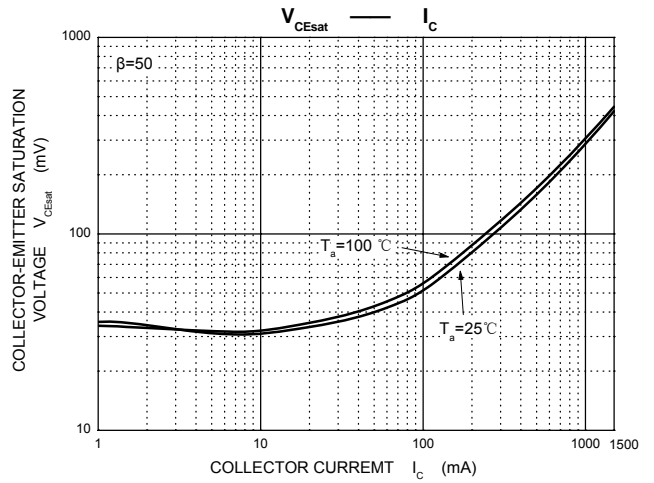
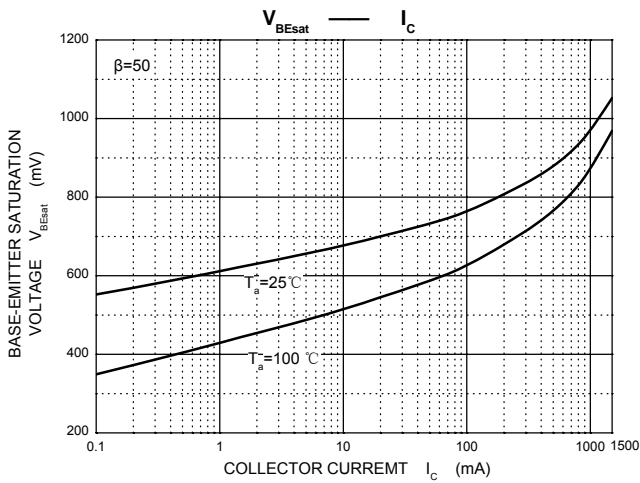
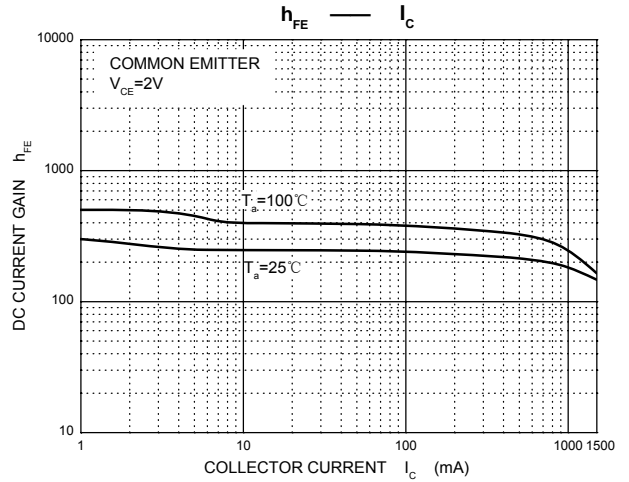
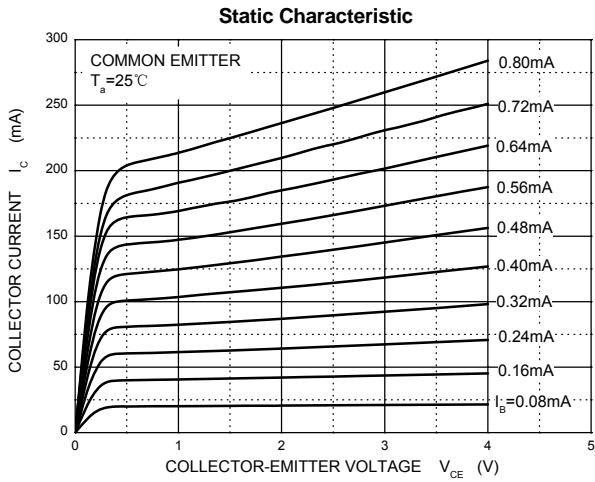

# Typical Characteristics

## PNP Transistor

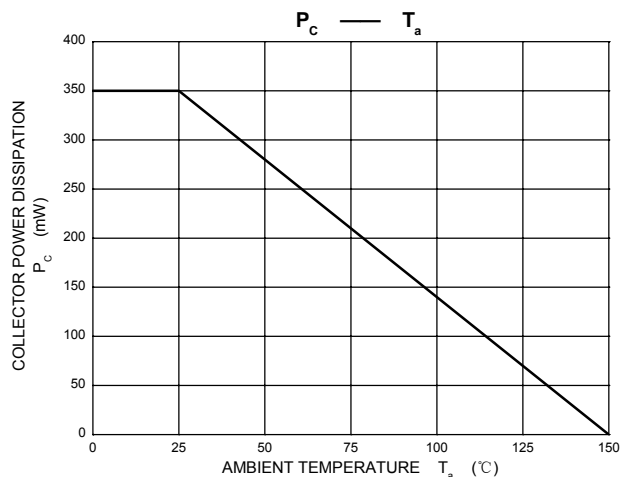
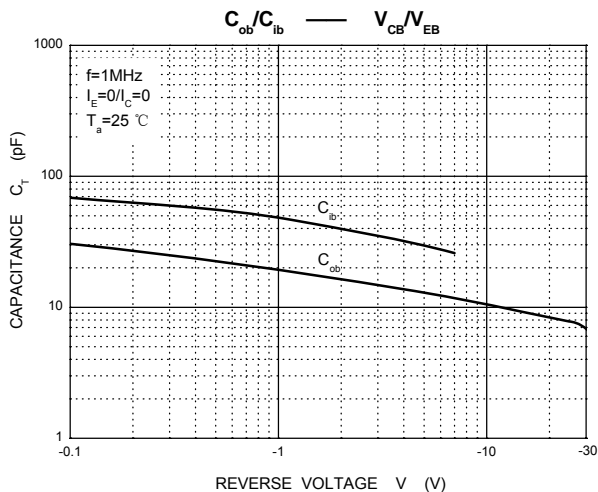
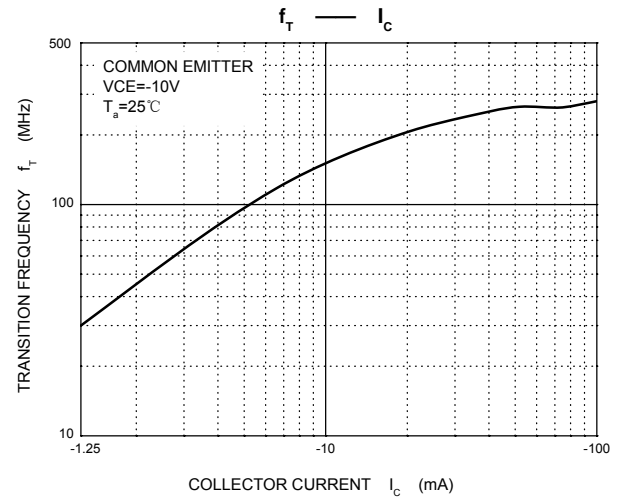
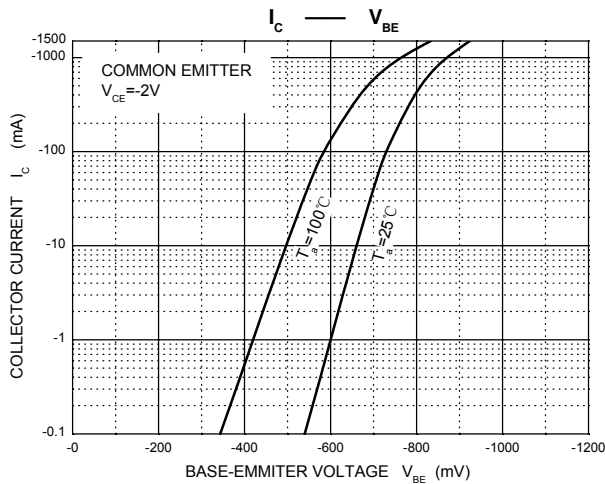
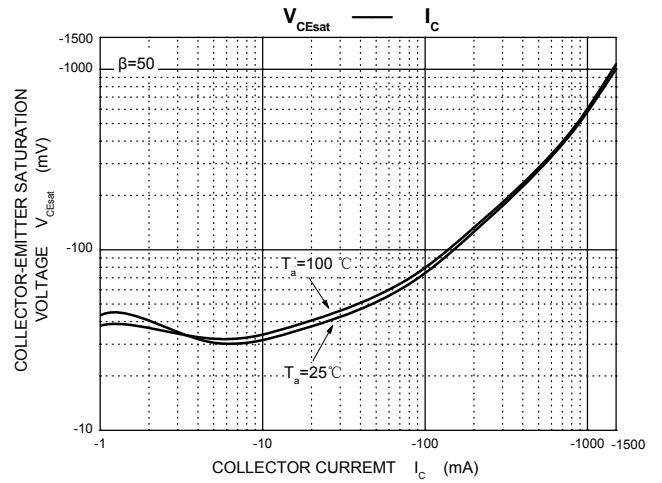
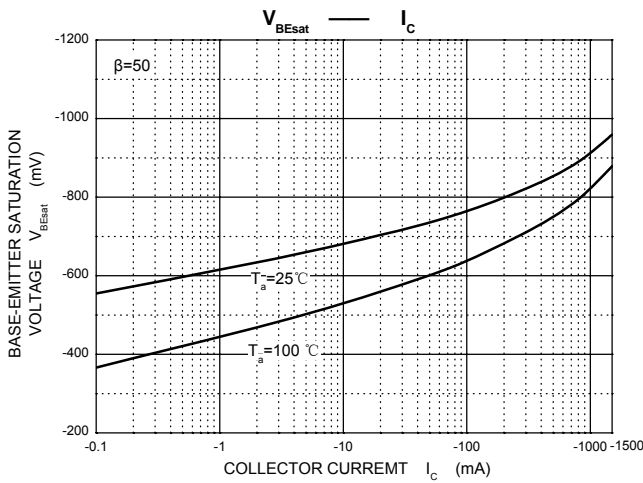
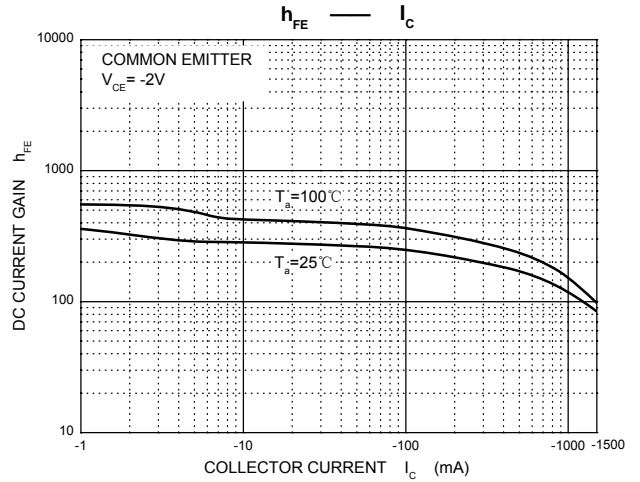
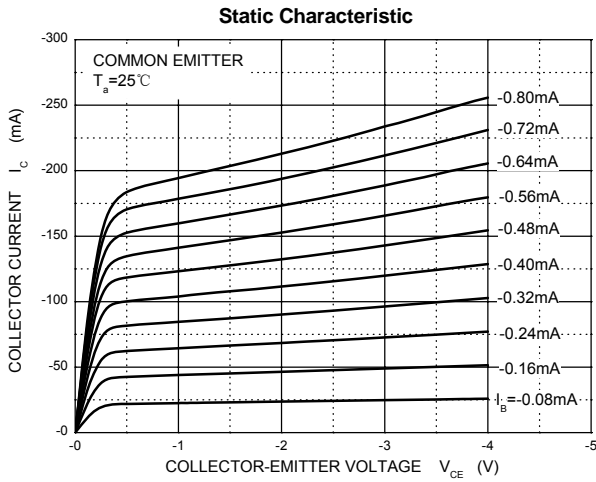

## SOT-23-6L Package Outline Dimensions

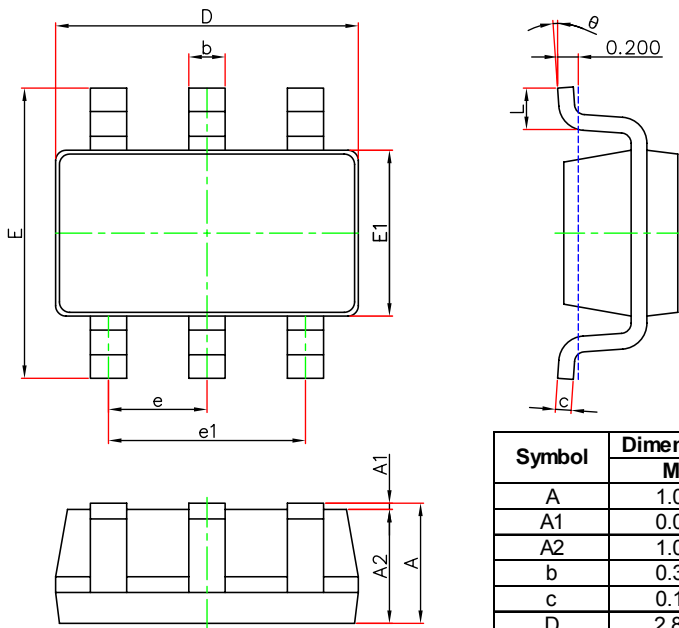

Symbol	Dimensions In Millimeters		Dimensions In Inches	
	Min.	Max.	Min.	Max.
A	1.050	1.250	0.041	0.049
A1	0.000	0.100	0.000	0.004
A2	1.050	1.150	0.041	0.045
b	0.300	0.500	0.012	0.020
c	0.100	0.200	0.004	0.008
D	2.820	3.020	0.111	0.119
E1	1.500	1.700	0.059	0.067
E	2.650	2.950	0.104	0.116
e	0.950(BSC)		0.037(BSC)	
e1	1.800	2.000	0.071	0.079
L	0.300	0.600	0.012	0.024
θ	0°	8°	0°	8°

## SOT-23-6L Suggested Pad Layout

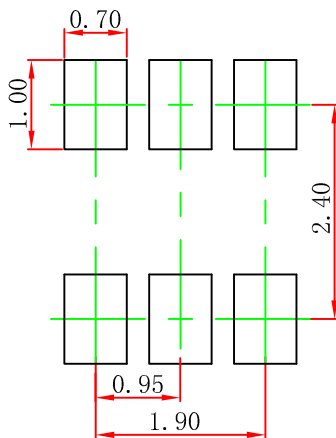

- Note:
1. Controlling dimension: in millimeters.
  2. General tolerance:  $\pm 0.05$  mm.
  3. The pad layout is for reference purposes only.

### NOTICE

JCET reserve the right to make modifications, enhancements, improvements, corrections or other changes without further notice to any product herein. JCET does not assume any liability arising out of the application or use of any product described herein.

# SOT-23-6L Tape and Reel

## SOT-23-6L Embossed Carrier Tape

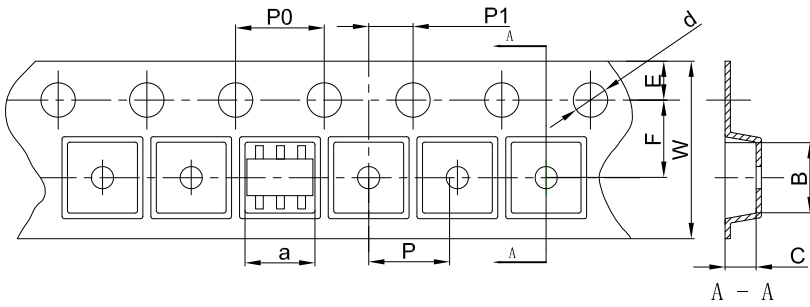

**Packaging Description:**

SOT-23-6L parts are shipped in tape. The carrier tape is made from a dissipative (carbon filled) polycarbonate resin. The cover tape is a multilayer film (Heat Activated Adhesive in nature) primarily composed of polyester film, adhesive layer, sealant, and anti-static sprayed agent. These reeled parts in standard option are shipped with 3,000 units per 7" or 18.0cm diameter reel. The reels are clear in color and is made of polystyrene plastic (anti-static coated).

Dimensions are in millimeter										
Pkg type	a	B	C	d	E	F	P0	P	P1	W
SOT-23-6L	3.17	3.23	1.37	Ø1.55	1.75	3.50	4.00	4.00	2.00	8.00

## SOT-23-6L Tape Leader and Trailer

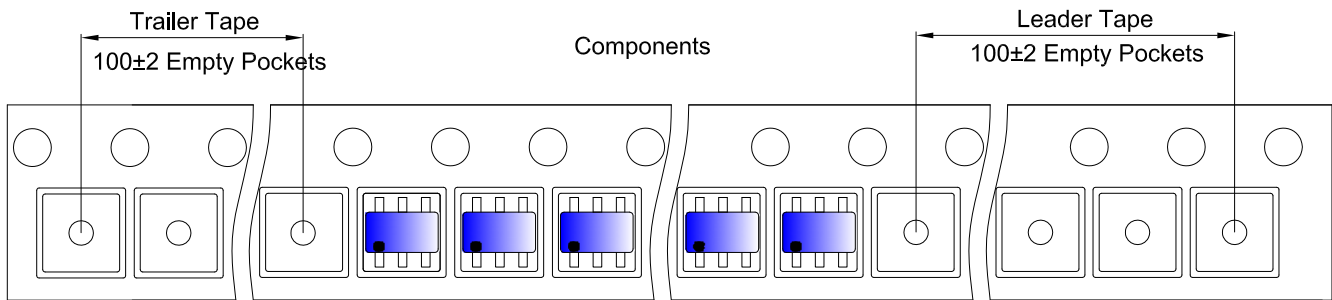

## SOT-23-6L Reel

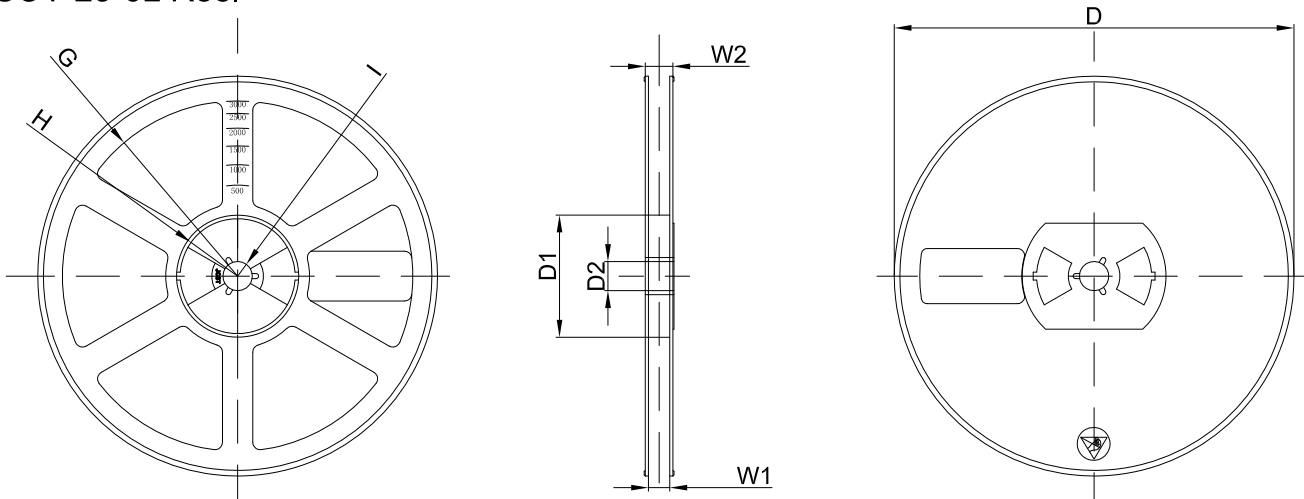

Dimensions are in millimeter								
Reel Option	D	D1	D2	G	H	I	W1	W2
7"Dia	Ø180.00	60.00	13.00	R78.00	R25.60	R6.50	9.50	13.10

REEL	Reel Size	Box	Box Size(mm)	Carton	Carton Size(mm)	G.W.(kg)
3000 pcs	7 inch	30,000 pcs	203×203×195	120,000 pcs	438×438×220	